

DC BLOWER 20x20x6MM

General Specifications

Material..... Frame: Plastic (UL94V-0)
 Impeller: Plastic (UL94V-0)
 Lead Wire: UL type or Equivalent (+) Red, (-) Black
 Insulation Resistance... 1 OMO Or Over With a DC250V Megger
 Temperature Range....Operating temperature -10°C~70°C (Non-condensing)
 Storage temperature -40°C~70°C (Non-condensing)



Specifications

Model	#Bearing Type	Rated Voltage	Operating Voltage	Input Current	Speed	Air Flow	Static Pressure	Noise	Weight
Part No.	HD	VDC	VDC	Amp	RPM	CFM	mm-H ₂ O	dB-A	g
E2006DBS5H	HD	5	4.5~5.5	0.16	15000	0.42	2.99	36.0	4.0
E2006DBS5M	HD	5	4.5~5.5	0.12	12000	0.33	2.39	28.8	4.0
E2006DBS5L	HD	5	4.5~5.5	0.08	9000	0.25	1.79	21.6	4.0

*HD=Hydraulic Bearing

Dimensions (Unit:mm)

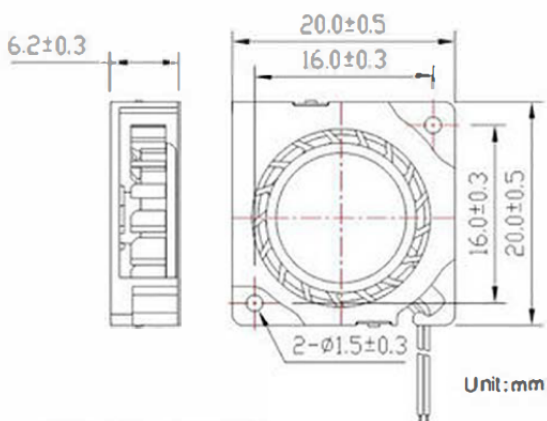

PQ Curve (At rated Voltage)

